



ASSEMBLY TOOLS AND SYSTEMS



Electric
Screwdrivers



DC Controlled screwdrivers

Torque Control System

A new way to optimize your tightening process



- Replace up to 8 Screwdrivers on your work bench thanks to 8 programmable digital Torque / Speed / Angle settings selectable through I/O or sensor ports.
- Set up to 8 counting programs with up to 20 screws each with different torque targets.

Best choice for Cell line Manufacturing



Easy PC Communication through USB Port



Screw counter inside (detect cross thread, screw omission...)



Tightening process management through 25P I/O port or sensor port



Built-in 32 Bit microprocessor



Data monitoring & Quality Control



Example of job selection through sensors

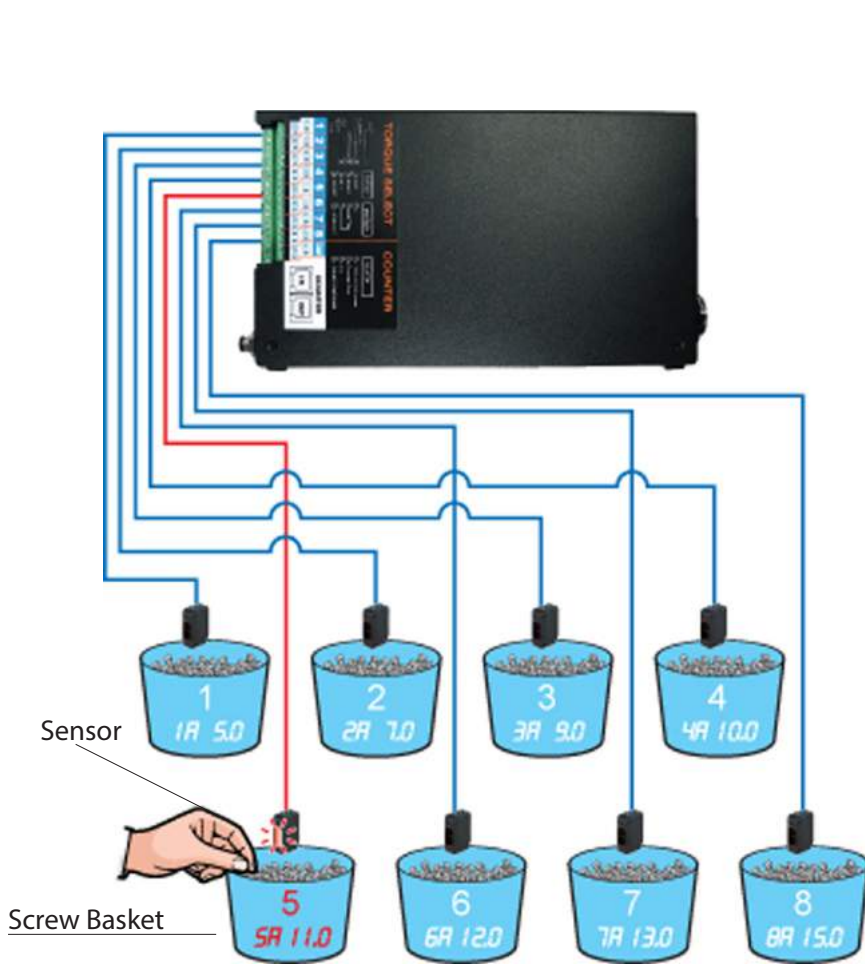

Job n° 5
Work Mode
Torque : 11 kgf.cm
(Default setting is torque (kgf.cm))

- Until 8 jobs setup (\neq Torque / Speed / Angle)/
- Each job n° is simply selected by the sensor when the operator picks up the screw or by the PLC thanks to the 25 I/O ports.
- 8 counting programs with torque sequencing.

Example

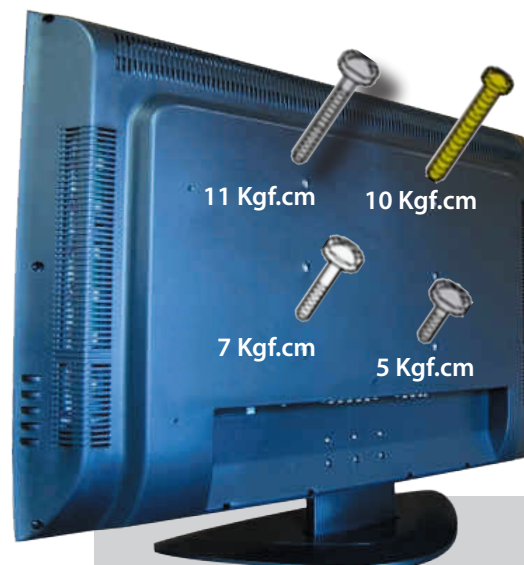
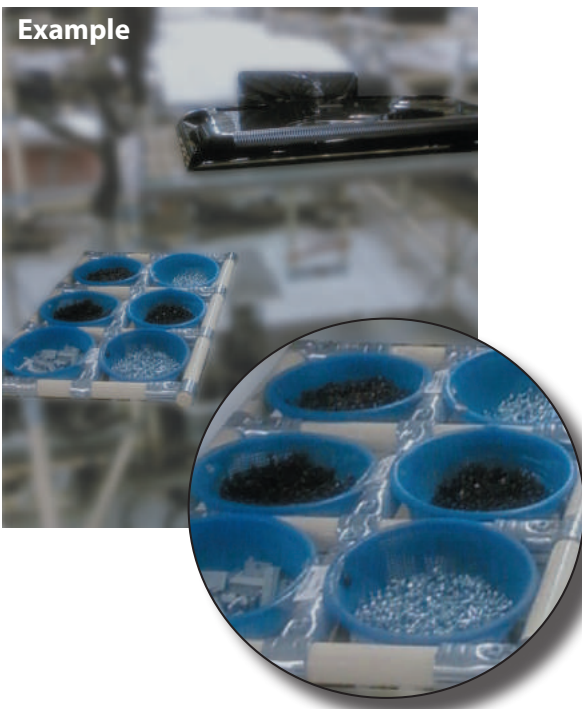

8 different jobs with one Hybrid screw driver.

Jobs may be selected as well through PLC, socket tray...



DC Controlled screwdrivers

HD Series

0,3 to 9,8 NM



- Brushless DC motor (service free)
- ESD free by body grounding
- Torque repeatability ~ 7%
- Inside memory chip for tool data and recognition
- Built - in air clutch
- Angle monitoring
- Sequencing programs
- Noise level < 70 dB
- Vibration level < 2,5 m/s²

PHD100N-A/D

HD100N-A

HD220A

HD150PA

40 Volts hybrid screwdrivers

0,3 - 4,4 Nm

Model	Torque Range (Nm)	Speed rotation (rpm)	Drive	Starting system	Weight (Kg)	Code
HD081A	0,3 - 0,78	1000 to 1700	Hex 1/4"	Lever	0,44	4-1058880
HD150A-G	0,5 - 1,5	500 to 1700	Hex 1/4"	Lever	0,44	4-1027470
HD220A-G	0,7 - 2,2	400 to 1250	Hex 1/4"	Lever	0,44	4-1027471
HD450A-G	0,98 - 4,4	300 to 600	Hex 1/4"	Lever	0,51	4-1027472
HD150PA-G	0,5 - 1,5	500 to 1700	Hex 1/4"	Push to start	0,44	4-1027473
HD220PA-G	0,7 - 2,2	400 to 1250	Hex 1/4"	Push to start	0,44	4-1027475
HD450PA-G	0,98 - 4,4	300 to 600	Hex 1/4"	Push to start	0,51	4-1027474

Standard packing : screwdriver, 14P-3M cable, test bits.

40 Volts hybrid spindles

0,5 - 4,4 Nm

Model	Torque Range (Nm)	Speed rotation (rpm)	Drive	Starting system	Weight (Kg)	Code
HDA150A	0,5 - 1,5	500 to 1700	Hex 1/4"	Remote	0,44	4-1042224
HDA220A	0,7 - 2,2	400 to 1250	Hex 1/4"	Remote	0,44	4-1042225
HDA450A	0,98 - 4,4	300 to 600	Hex 1/4"	Remote	0,51	4-1042226

Standard packing : screwdriver, 14P-3M cable, test bits.

35 Volts hybrid screwdrivers

1,17 - 9,8 Nm

Model	Torque Range (Nm)	Speed rotation (rpm)	Drive	Starting system	Shape	Weight (Kg)	Code
HD35N-A	1,17 to 3,4	500 to 1500	Hex 1/4"	Lever	Straight	0,7	4-1077880
HD50N-A	1,47 to 4,9	300 to 1050	Hex 1/4"	Lever	Straight	0,7	4-1077881
HD100N-A	3 to 9,8	250 to 500	Hex 1/4"	Lever	Straight	0,75	4-1077882
HD35NP-A	1,17 to 3,4	500 to 1500	Hex 1/4"	Push to start	Straight	0,7	4-1070035
HD50NP-A	1,47 to 4,9	300 to 1050	Hex 1/4"	Push to start	Straight	0,7	4-1070036
PHD35N-A/U*	1,17 to 3,4	500 to 1500	Hex 1/4"	Trigger	Pistol	0,82	4-1070032
PHD50N-A/U*	1,47 to 4,9	400 to 1100	Hex 1/4"	Trigger	Pistol	0,82	4-1070033
PHD100N-A/U*	3 to 9,8	250 to 500	Hex 1/4"	Trigger	Pistol	0,86	4-1070034
PHD35N-A/D**	1,17 to 3,4	500 to 1500	Hex 1/4"	Trigger	Pistol	0,82	4-1070040
PHD50N-A/D**	1,47 to 4,9	400 to 1100	Hex 1/4"	Trigger	Pistol	0,82	4-1070041
PHD100N-A/D**	3 to 9,8	250 to 500	Hex 1/4"	Trigger	Pistol	0,86	4-1070042

Standard packing : screwdriver, 14P-3M cable, test bits.

* : Top exit cable

** : handle exit cable

Controllers



- Com port usage selector
- USB Port for PC communication or firmware upgrade
- 25P I/O interface
- RS-232C Port
- Air pressure inlet (out dia 4 mm)

HDC-40i/HDC-35i

- Delivered with USB Com cable, air filter, air hose.

No	ITEM	SPECIFICATION	
1	Model	HDC-40i - 4-1042211 for HD40 V	HDC-35i - 4-1077883 for HD35 V
2	Input	Electric	AC120VC ou AC220V, 50~60 Hz/0,5 A
3		Air pressure	Min 5 bar/Max 6,5 bar
4	Output	Electric	DC40V, 3A
5	Fuse		AC250V, 10A
6	Dimension/Weight		104(w) 226,4(d) 144(h)mm / 2,6 Kg
7	Job parameters	Torque, Speed, Angle, Soft start, Torque tuning in 8 preset numbers	
8	Job selection	1) Front panel button 2) 25P I/O interface 3) F1 button on the driver	
9	Torque Calibration	From - 20% to +20%	
10	Auto detection of the connected Driver	Auto detection of the offset value from the EEP-rom inside the driver	
11	Error display	Error display by code no. in system, communication & pattern error group	
12	Fastening quality control	OK/NG monitoring of screw fastening by preset pattern of angles, times	
13	Screw Counter	Save the total screw number, and monitor the number of OK fastenings.	
14	Monitoring and parameter	Monitoring and parameter settings on PC program (MS Windows base)	
15	Communication port	USB or RS232C (option)	
16	Built in counter program	8 counting programs, 20 screws per program. Auto-sequencing of fastening strategies.	

Accessoires



Driver Cable 3M

Delivered with the tool
Code : 4-1042205
Option driver table 5m:
Code : 4-1042250

Standard :



USB Com Cable

Delivered with the controller
Code : 4-1042213

Options :



Pistol Grip for HD-G 40V
Code : 4-1042210
I/O sub-D25 cable
Code : 4-1200770



Angle head kit for 1/4" square HD-G 40V
Code : 4-1000251
Angle head kit for 1/4" HD220/450
Code : 4-1000111
Angle head kit for 1/4" Hex HD35/50/100
Code : 4-1000110



DC Controlled screwdrivers

SD Series 

0,016 to 2,7 NM



- Noise level < 70 dB
- Vibration level < 2,5 m/s²
- Sequency programs
- 24V Swiss DC Servo motor
- Over 5 millions cycles of life expectancy
- Torque accuracy 10 % in full scale
- Torque repeatability ±3%
- 190 - 1000 rpm Speed control (scale : 50 rpm)
- 8 programs memory
- Real time monitoring - torque, rpm, angle
- ESD free with conductive material
- Suitable for clean room
- Real time torque and angle curve
- Auto speed : optimized speed/torque target

Model	Starting system	Torque Range (Nm)	Autospeed** (rpm)	Manual speed (rpm)	Drive	Weight (Kg)	Controller	Code
SDA 120-E/FV	Remote	0,016 - 0,15	240 to 1000	150 to 1000	Half-moon 4 mm	0,46	SDC-24	4-1000238
SDA 200-E/FV	Remote	0,05 - 0,2	420 to 1000	300 to 1000	Half-moon 4 mm	0,46	SDC-24	4-1000239
SDA 300-E/FV	Remote	0,1 - 0,3	360 to 890	200 to 1000	Half-moon 4 mm	0,46	SDC-24	4-1000240
SDA 600-A/FV	Remote	0,15 - 0,6	190 to 710	150 to 1000	1/4" Hex	0,46	SDC-24	4-1088880
SDA1000-A/FV	Remote	0,19 - 0,98	130 to 430	100 to 750	1/4" Hex	0,67	SDC-24	4-1000246
SDA 05 N-A	Remote	0,11 - 0,48	300 to 1000	100 to 1000	1/4" Hex	0,68	SDC-40	4-1000266
SDA 09 N-A	Remote	0,15 - 0,87	300 to 1000	100 to 1000	1/4" Hex	0,69	SDC-40	4-1000267
SDA 18N-A-FV	Remote	0,4 - 1,7	300 to 1000	100 to 1000	1/4" Hex	0,75	SDC-40	4-1041800
SDA28N-A-FV	Remote	0,5 - 2,7	190 to 1000	100 to 1000	1/4" Hex	0,75	SDC-40	4-1000248
SD 120-E	Lever	0,03 - 0,15	240 to 1000	150 to 1000	Half-moon 4 mm	0,26	SDC-24	4-1000241
SD 200-E	Lever	0,05 - 0,2	420 to 1000	300 to 1000	Half-moon 4 mm	0,3	SDC-24	4-1000242
SD 300-E	Lever	0,1 - 0,3	360 to 890	200 to 1000	Half-moon 4 mm	0,3	SDC-24	4-1000243
SD 600-A	Lever	0,15 - 0,6	190 to 710	150 to 1000	1/4" Hex	0,33	SDC-24	4-1077801
SD1000-A	Lever	0,19 - 0,98	130 to 430	100 to 750	1/4" Hex	0,38	SDC-24	4-1077800
SD1500-A	Lever	0,3 - 1,47	120 to 399	100 to 700	1/4" Hex	0,38	SDC-24	4-1000596
SD05N-A	Lever	0,11 - 0,48	300 to 1000	100 to 1000	1/4" Hex	0,64	SDC-40	4-1000268
SD09N-A	Lever	0,15 - 0,87	300 to 1000	100 to 1000	1/4" Hex	0,65	SDC-40	4-1000269
SD18N-A	Lever	0,4 - 1,7	300 to 1000	100 to 1000	1/4" Hex	0,75	SDC-40	4-1000252
SD28N-A	Lever	0,5 - 2,7	190 to 780	100 to 1000	1/4" Hex	0,75	SDC-40	4-1000253

** : optimized speed according torque target.

SDA : fixtured spindle

SD : hand held, lever start

Real time torque & angle curve

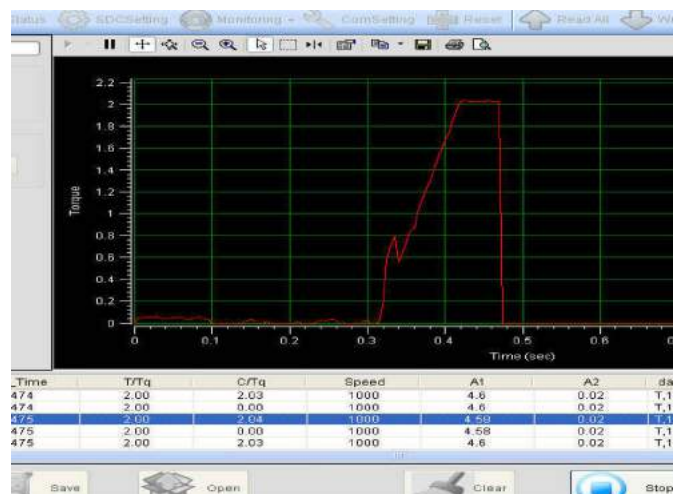

Controller

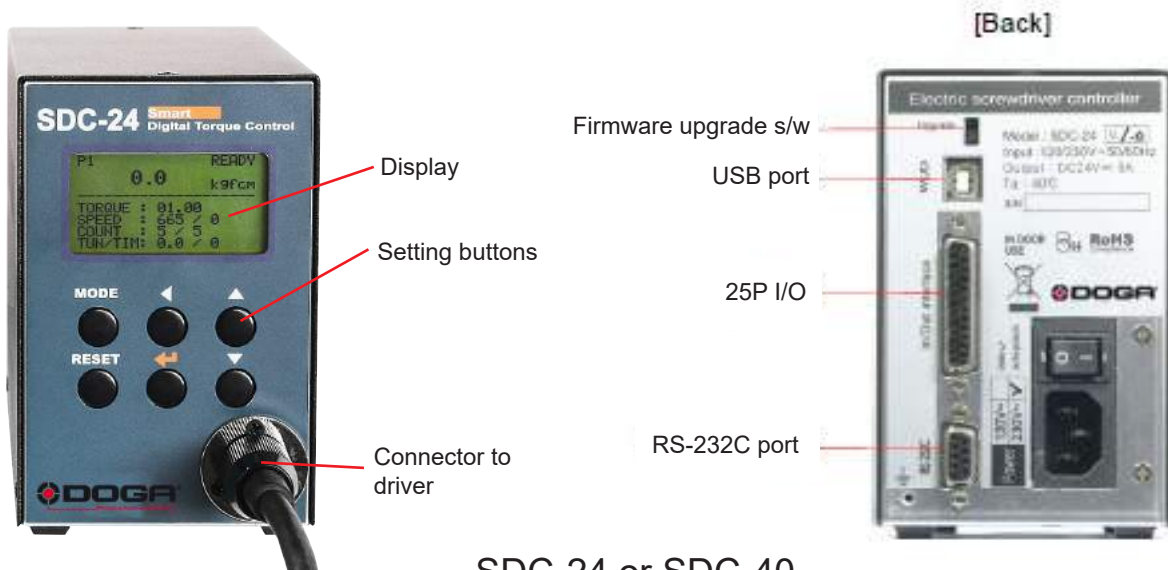

SDC-24 or SDC-40

No	Item	SDC-24 Code 4-1000245	SDC-40 Code 4-1041801
1	Input	AC120VC or AC220V, 50-60Hz 2A 3A	
2	Output	DC24V, 5A	DC40V, 3A
3	Control Range	Torque	0,1 - 1,47 Nm 0,1 - 2,7 Nm
		Speed	100 - 1,000 rpm 300 - 1000 rpm
		Angle	0,4° step
4	Preset parameters	Torque, (Speed) & Angle	
5	Preset # selecting	1) Front panel button 2) 25P I/O interface	
6	Torque calibration	-10% - + 10%	
7	Auto recognition	Auto detection of connected driver when power ON of controller	
8	Error display	Error code display (3 groups)	
9	Fastening quality control	Fastening data verification (NG/OK) against the pre-setting pattern of angle	
10	Screw counter	Total 8 programs of tightening screw number and sequence	
11	Parameter setting and monitoring	MS Windows PC software, Smart-Manager of front panel	

ACCESSORIES : (delivered with the controller)
 - Driver cable SD 10 PC, 3 M **Code : 4-1074440**
 - USB com cable **Code : 4-1042213**

OPTION :
 - 5 meters tool cable **Code : 4-1074420**
 - I/O sub-d25 male cable **Code : 4-1200770**



Software

Smart Manager (SD Series)/Hi-Manager (HD Series)

Set and monitor your tool,
your tightening environment on
free PC Software,



Job settings
(Torque,
Speed, Angle,
Soft start,
Torque tuning)

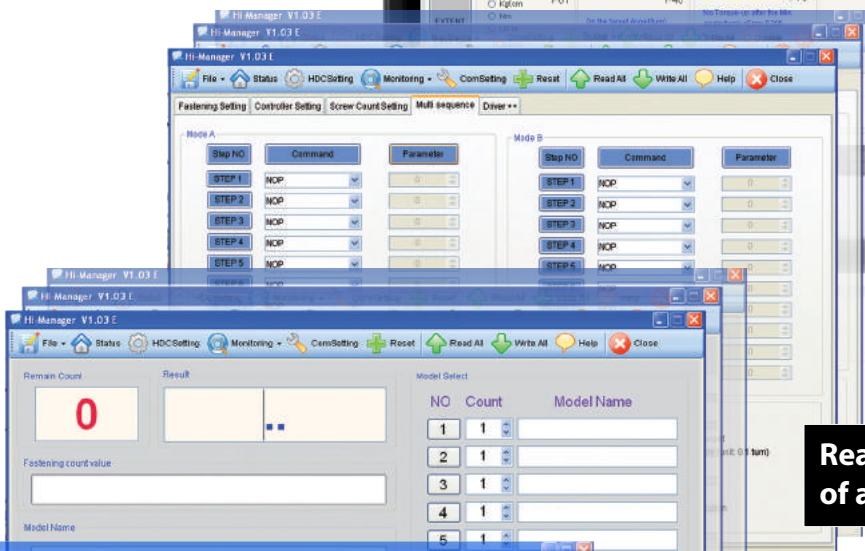

Real time readings
of all tightenings



Screw counter
process Monitoring

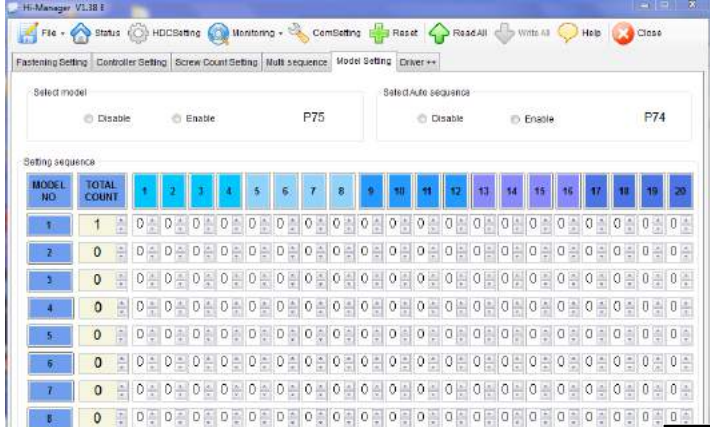

Error Monitoring

Built-in counting program
with torque sequencing

GX Series

Brushless

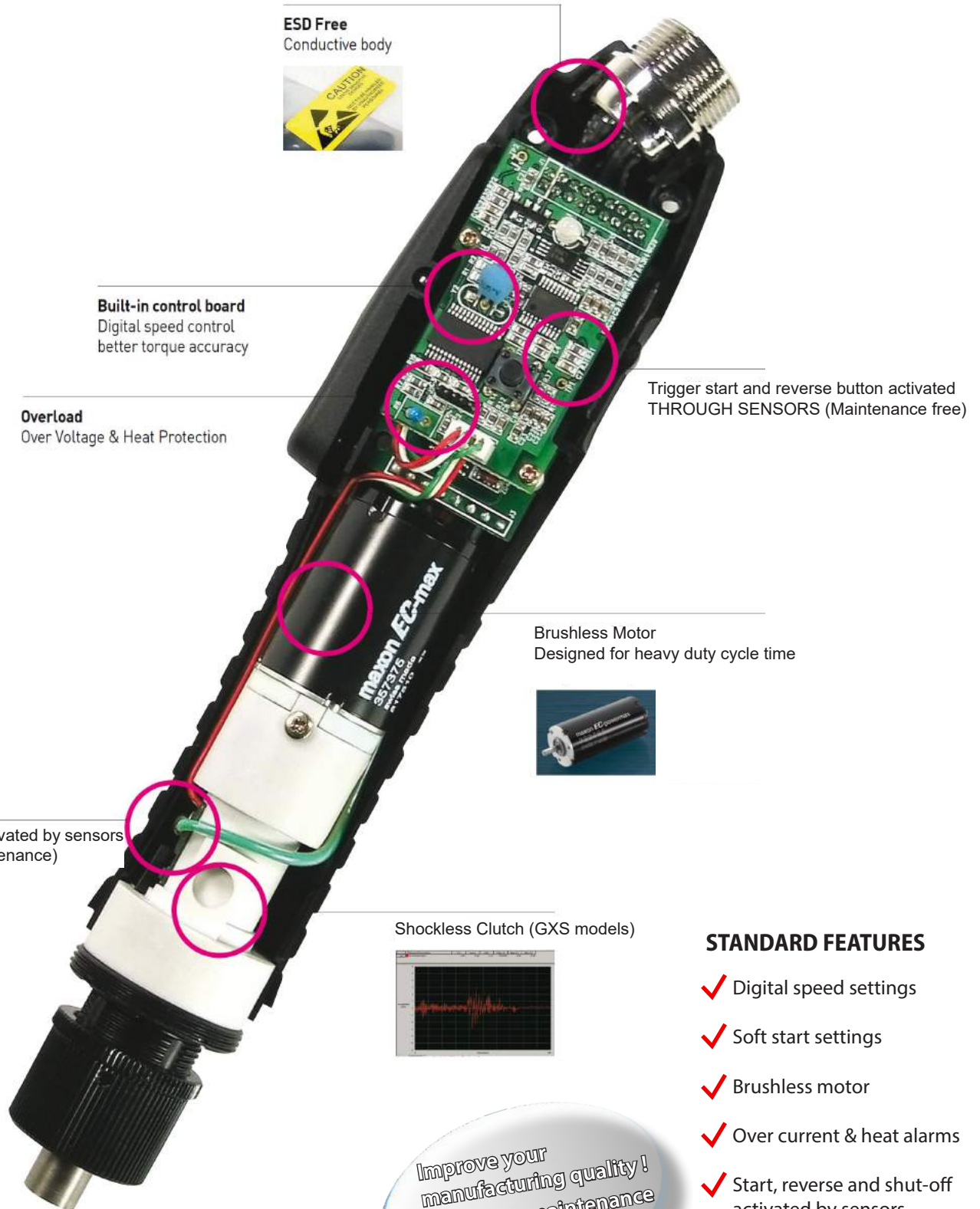

ESD Free
Conductive body



Built-in control board
Digital speed control
better torque accuracy

Overload
Over Voltage & Heat Protection

Trigger start and reverse button activated
THROUGH SENSORS (Maintenance free)

Brushless Motor
Designed for heavy duty cycle time



Clutch activated by sensors
(No maintenance)

Shockless Clutch (GXS models)

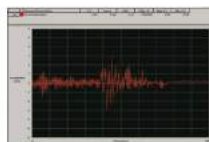

STANDARD FEATURES

- ✓ Digital speed settings
- ✓ Soft start settings
- ✓ Brushless motor
- ✓ Over current & heat alarms
- ✓ Start, reverse and shut-off activated by sensors

Improve your
manufacturing quality!
Lower your maintenance
cost!



GX Series

30 Volts • Auto-shut off • $\text{C}\epsilon$ XS-40D (FA) Controller 

0,02 to 1,2 NM



VACCUM System (Optional) • 

- Higher productivity : thanks to high Brushless motor efficiency !
- Higher comfort : thanks to improved ergonomoy and reduced sound level and heat !
- Increased economy : thanks to brushless motor (triple the life time of the motor).
- Reduced maintenance : the best Mean Time Between Failure (MTBF) ever reached until now (no carbon brush, trigger and reverse contactless switches, over-heat and over-current built in alarms protecting the screwdrivers).
- Increased production quality : thanks to ESD protection, accurate clutch and Softstop clutch Mechanism.
- Noise level : <70 dBA, vibration level : <2,5 m/s²

Micro Torque GX Series *(features SOFT STOP clutch and Digital speed setting)*

Model	Torque Range (Nm)	Speed rotation (rpm)	Starting system	Drive	Weight (Kg)	Code
GX 035 ESD	0,02 - 0,34	300 to 1100	Lever	Half moon/shank drive 4mm	0,24	4-1040077
GX 045 ESD	0,04 - 0,45	300 to 700	Lever	Half moon/shank drive 4mm	0,24	4-1040078

Suitable controller : XS-40D - To be ordered seprately - See page 17

STANDARD Series : GX with digital speed and soft start

Model	Torque Range (Nm)	Speed rotation (rpm)	Starting system	Drive	Weight (Kg)	Code
GX 80 ESD V2	0,09 - 0,8	450 to 1000	Lever	Hex 1/4"	0,43	4-1021025
GX 120 ESD V2	0,2 - 1,2	300 to 700	Lever	Hex 1/4"	0,43	4-1021026
GX 80 P ESD V2	0,09 - 0,8	450 to 1000	Push to start	Hex 1/4"	0,43	4-1021027
GX 120 P ESD V2	0,2 - 1,2	300 to 700	Push to start	Hex 1/4"	0,43	4-1021028

Suitable controller : XS-40D - To be ordered seprately - See page 17

SOFT STOP Series : GXS *(built-in special clutch mechanism providing soft shut-off to protect fragile parts)*

Model	Torque Range (Nm)	Speed rotation (rpm)	Starting system	Drive	Weight (Kg)	Code
GXS 80 ESD V2	0,09 - 0,8	450 to 1000	Lever	Hex 1/4"	0,43	4-1021020
GXS 120 ESD V2	0,2 - 1,2	300 to 700	Lever	Hex 1/4"	0,43	4-1021021

Suitable controller : XS-40D - To be ordered seprately - See page 17

TIMER & AUTOREVERSE Series : GXT *(fasten at preset angle/time, Automatic Reverse/forward, stop sequence - ideal for tapping operation, helicoil fastening, pre-assembly...)*

Model	Torque Range (Nm)	Speed rotation (rpm)	Starting system	Drive	Weight (Kg)	Code
GXT 80 ESD V2	0,09 - 0,8	450 to 1000	Lever	Hex 1/4"	0,43	4-1021036
GXT 120 ESD V2	0,2 - 1,2	300 to 700	Lever	Hex 1/4"	0,43	4-1021037

Suitable controller : XS-40D - To be ordered seprately - See page 17

FIXTURED SPINDLES Series : GXA *(for automation choose XS-40D FA controller - Code 6-1040080)*

Model	Torque Range (Nm)	Speed rotation (rpm)	Starting system	Drive	Weight (Kg)	Code
GXA 035 ESD V2	0,03 - 0,35	300 to 1100	Remote	Half moon/shank drive 4mm	0,45	4-1040079
GXA 045 ESD V2	0,04 - 0,45	300 to 700	Remote	Half moon/shank drive 4mm	0,45	4-1040076
GXA 080 ESD V2	0,1 - 0,8	450 to 1000	Remote	Hex 1/4"	0,45	4-1040074
GXA 120 ESD V2	0,2 - 1,2	300 to 700	Remote	Hex 1/4"	0,45	4-1040075

* The whole models of this series are delivered with one tool cable (3m) + sample powerbits.

GX-H Series

40 Volts • Auto-shut off • CE • XS-40D Controller 

0,3 to 4,4 NM



- Higher productivity : thanks to high Brushless motor efficiency !
- Higher comfort : thanks to improved ergonomoy and reduced sound level and heat !
- Increased economy : thanks to brushless motor (triple the life time of the motor).
- Reduced maintenance : the best Mean Time Between Failure (MTBF) ever reached until now (no carbon brush, trigger and reverse contactless switches, over-heat and over-current built in alarms protecting the screwdrivers).
- Increased production quality : thanks to ESD protection, accurate clutch and Softstop clutch Mechanism.
- Noise level : <70 dBA, vibration level : <2,5 m/s²

STANDARD Series : GX with digital speed setting and soft start

Model	Torque Range (Nm)	Speed rotation (rpm)	Starting system	Drive	Weight (Kg)	Code
GX 150 ESD-H	0,3 - 1,47	800 to 1700	Lever	Hex 1/4"	0,60	4-1027477
GX 220 ESD-H	0,6 - 2,15	600 to 1200	Lever	Hex 1/4"	0,60	4-1027478
GX 450 ESD-H	1 - 4,41	300 to 600	Lever	Hex 1/4"	0,62	4-1027479
GX 150 P ESD-H	0,3 - 1,47	800 to 1700	Push to Start	Hex 1/4"	0,60	4-1027480
GX 220 P ESD-H	0,6 - 2,15	600 to 1200	Push to Start	Hex 1/4"	0,60	4-1027481
GX 450 P ESD-H	1 - 4,41	300 to 600	Push to Start	Hex 1/4"	0,62	4-1027482

Suitable controller : XS-40D - To be ordered separately - See page 17

SOFT STOP Series : GXS (built-in special clutch mechanism providing soft shut-off to protect fragile parts)

Model	Torque Range (Nm)	Speed rotation (rpm)	Starting system	Drive	Weight (Kg)	Code
GXS 150 ESD-G	0,3 - 1,47	800 to 1700	Lever	Hex 1/4"	0,60	4-1027486
GXS 220 ESD-G	0,6 - 2,15	600 to 1200	Lever	Hex 1/4"	0,60	4-1027487
GXS 450 P ESD-G	1 - 4,41	300 to 600	Lever	Hex 1/4"	0,62	4-1027488

Suitable controller : XS-40D - To be ordered separately - See page 17

TIMER & AUTOREVERSE Series : GXT (fasten at preset angle/time, Automatic Reverse/forward stop sequence - ideal for tapping operation, helicoil fastening, pre-assembly...)

Model	Torque Range (Nm)	Speed rotation (rpm)	Starting system	Drive	Weight (Kg)	Code
GXT 150 ESD-H	0,3 - 1,47	800 to 1700	Lever	Hex 1/4"	0,60	4-1027489
GXT 220 ESD-H	0,6 - 2,15	600 to 1200	Lever	Hex 1/4"	0,60	4-1027490
GXT 450 ESD-H	1 - 4,41	300 to 600	Lever	Hex 1/4"	0,62	4-1027491

Suitable controller : XS-40D - To be ordered separately - See page 17

FIXTURED SPINDLE FOR AUTOMATION (for automation choose XS-40D FA controller - Code 4-1040080)

Model	Torque Range (Nm)	Speed rotation (rpm)	Starting system	Drive	Weight (Kg)	Code
GXA 150-H	0,3 - 1,47	800 to 1700	Remote	Hex 1/4"	0,72	4-1027483
GXA 220-H	0,6 - 2,15	600 to 1200	Remote	Hex 1/4"	0,72	4-1027484
GXA 450-H	1 - 4,41	300 to 600	Remote	Hex 1/4"	0,74	4-1027485
GXA 150P-H	0,3 - 1,47	800 to 1700	Push to start	Hex 1/4"	0,79	4-1027492
GXA 220P-H	0,6 - 2,15	600 to 1200	Push to start	Hex 1/4"	0,79	4-1027493
GXA 450P-H	1 - 4,41	300 to 600	Push to start	Hex 1/4"	0,74	4-1027494

* The whole models of this series are delivered with one tool cable (3m) + sample powerbits.



GY Series

35 Volts • CE • XT-35D Controller 

0,7 to 9,8 NM

- Excellent ratio Weight / Ergonomy / Power
- BLDC motor (maintenance free)
- High speed from 300 to 1500 rpm (3 models)
- Designed for high production rate
- Motor efficiency 85%
- Low Noise, Low Heat, less Energy consumption
- Over Heat, Over Load, Over Voltage protection circuit with LED display
- ESD free with conductive plastic body (less than 10000 hms)
- Noise level : <70 dBA, vibration level : <2,5 m/s²



Model	Torque Range (Nm)	Speed Rotation (rpm)	Starting system	Drive	Weight (Kg)	Code
GY35 ESD-G	0,7 - 3,4	500 to 1500	Lever	Hex 1/4"	0,8	4-1064100
GY50 ESD-G	1 - 4,9	400 to 1100	Lever	Hex 1/4"	0,8	4-1064102
GY100 ESD-G	3,9 - 9,8	250 to 500	Lever	Hex 1/4"	0,85	4-1064104
GY35P ESD-G	0,7 - 3,4	500 to 1500	Push to start	Hex 1/4"	0,8	4-1064101
GY50P ESD-G	1 - 4,9	400 to 1100	Push to start	Hex 1/4"	0,8	4-1064103
GYA35 ESD-G V2	0,7 - 3,4	500 to 1500	Remote	Hex 1/4"	0,95	4-1064105
GYA50 ESD-G V2	1 - 4,9	400 to 1100	Remote	Hex 1/4"	0,95	4-1064106
GYA100 ESD-G V2	1 - 9,8	250 to 500	Remote	Hex 1/4"	0,95	4-1064107
PGY35 pistol ESD-G	0,7 - 3,4	500 to 1500	Trigger	Hex 1/4"	0,9	4-1078015
PGY50 pistol ESD-G	1 - 4,9	400 to 1100	Trigger	Hex 1/4"	0,9	4-1078016
PGY100 pistol ESD-G	1 - 9,8	250 to 500	Trigger	Hex 1/4"	0,95	4-1078017
PGY35 T pistol Top Exit ESD-G	0,7 - 3,4	500 to 1500	Trigger	Hex 1/4"	0,9	4-1078018
PGY50 T pistol Top Exit ESD-G	1 - 4,9	400 to 1100	Trigger	Hex 1/4"	0,9	4-1078019
PGY100 T pistol Top Exit ESD-G	1 - 9,8	250 to 500	Trigger	Hex 1/4"	0,95	4-1078020

* The whole models of this series are delivered with one tool cable (3m) + sample powerbits.

GX FS... Series

30 VDC High Speed • CE • XS-40D Controller 

0,1 to 1,8 NM

- Excellent Ergonomy (smart and small sized)
- BLDC motor (maintenance free)
- High speed from 680 - 1550 rpm (4 models)
- Motor efficiency 85%
- Low Noise, Low Heat level
- Over Heat, Over Load, Over Voltage protection circuit with LED display
- ESD free with conductive plastic body (less than 10000 hms)
- Noise level : <70 dBA, vibration level : <2,5 m/s²



Model	Torque Range (Nm)	Speed Rotation (rpm)	Starting system	Drive	Weight (Kg)	Code
GX60 FS ESD	0,1 - 0,60	1550	Lever	Hex 1/4"	0,44	4-1055960
GX80 FS ESD	0,2 - 0,80	1250	Lever	Hex 1/4"	0,44	4-1055962
GX120 FS ESD	0,3 - 1,20	1000	Lever	Hex 1/4"	0,44	4-1055964
GX180 FS ESD	0,4 - 1,80	700	Lever	Hex 1/4"	0,44	4-1055966
GX60FSP ESD	0,1 - 0,60	1550	Push to start	Hex 1/4"	0,44	4-1055961
GX80FSP ESD	0,2 - 0,80	1250	Push to start	Hex 1/4"	0,44	4-1055963
GX120FSP ESD	0,3 - 1,20	1000	Push to start	Hex 1/4"	0,44	4-1055965
GX180FSP ESD	0,4 - 1,80	700	Push to start	Hex 1/4"	0,44	4-1055967

* The whole models of this series are delivered with one tool cable (3m) + sample powerbits.
Suitable controller : XS-40D - To be ordered sepraty - See page 17

GX...BT Series

35 Volts • High Torque/Speed with Built-in speed and soft start selector • CE • XS-35D Controller 

1 to 9,8 NM

- Built Electronics with Embedded Speed and soft start settings
- BLDC motor (maintenance free)
- Low Noise, Low Heat, less Energy consumption
- Overt Heat, Over Load, Over Voltage protection circuit with LED display
- ESD free through bit socket grounded
- Noise level : <70 dBA, vibration level : <2,5 m/s²



Model	Torque Range (Nm)	Speed Rotation (rpm)	Starting system	Drive	Weight (Kg)	Code
GX35 BT ESD-G	1 - 3,4	700 to 1500	Lever	Hex 1/4"	0,92	4-1078005
GX50 BT ESD-G	2 - 4,9	600 to 1050	Lever	Hex 1/4"	0,92	4-1078006
GX100 BT ESD-G	4 - 9,8	150 to 550	Lever	Hex 1/4"	0,92	4-1078007

* The whole models of this series are delivered with one tool cable (3m) + sample powerbits.
Suitable controller : XS-35D - See page 18



Accessories





For GX/GX-G/GX-H Series

Screw vacuum pick up



For GX/GXA	For SD/SDA	Vacuum system
GX30 Volts 4-1084103 GX40 Volts 4-1000230 GX30 Volts with torque ring cover 4-1000270 GX150/220 ESD-G40 Volts 4-1084100 GX450 ESD-G40 Volts 4-1084101 GXA ESD-G40 Volts 4-1084102 GXA ESD-G30 Volts 4-1000039 GX Micro 4-1052501 GX 150/220-H 4-1027496 GX 450-H 4-1027497 GXA-H 4-1027498 Vacuum pick up are delivered without the sleeve gun (on request).	SD18N/28N + SDA600/1000/18N/28N 4-1052502 SDA120/200/300 4-1052503 SD05N/09N + SDA05N/09N4- 1052504 SD600/1500 4-1052505 SD1000 4-1052506 SD120/200/300 4-1052507	Vacuum pump DLP2570 4-3004101 

Accessories

			
Designation	Torque ring cover*		Square 1/4"
Code	4-1041213 GX 30 Volts 4-1041205 GX 40 Volts 4-1078800 GX-G 40 Volts 4-1027495 GX-H 40 Volts 4-1000232 GX...045 4-1000233 GX...BT, GY, PGY, GX...BT-G, GY-G, PGY-G 4-1077500 for GX...FS	Spiral cable 3,5 m 4-1010413 Standard cable 3,0 m 4-1041225 Standard cable 5,0 m 4-1044703 Reinforced cable 3,0 m 4-1000026	Angle head kit for GX30 Volts 4-1000226 (except Micro GX) Angle head kit for GX150/220 ESG-G 40 Volts 4-1000302 Angle head kit for GX450 ESD-G 40 Volts 4-1000229 Angle head kit for GX 40 Volts 4-1000227 Angle head kit for GX-H on request E 6,3 Hex. female 1/4" drive (quick release) Angle head kit for GX...BT/GX...BT-G/GY/GY-G 4-1033300
			C 6,3 Hex. female 1/4" drive
Designation	Programming Lock key**	Programming Lock key firmware upgrade**	Angle head kit for GX30 Volts 4-1000247 (except Micro GX) Angle head kit for GX40 Volts 4-1000249 Angle head kit for GX150/220 ESD-G 40 Volts 4-1000254 Angle head kit for GX450 ESD-G 40 Volts 4-1000255 Angle head kit for GX-H on request
Code	4-1044850	4-1000222	Mounting of Angle head 4-1000257

*Not suitable with vacuum pickup.

** Available only for standard series GX 30 & 40 Volts - To be ordered together.





Model	Designation	Code
	Cable 5m (GY-PGY) 4-1078888	Pistol grip for 40 Volts 4-1000231 for GX 30 Volts (except for Micro GX and GX-FS) 4-1010420 for GX/GX-G/GX-H 40 Volts
4-1588700		
	Cable 3m (GY-PGY) 4-1077200	
	For mounting on reaction arm from the top	4-1045804 for GX 30 Volts* 4-1045801 for GX/GX-G/GX-H 40 Volts 4-1045803 for GX...BT 4-1045800 for GY/HD 35 Volts 4-1045802 for HD 40 Volts 4-1045805 for GX...FS
	For mounting on reaction arm from below	4-1041501 for GX 30 Volts*

PLC Interface

* Except GX Micro

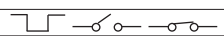
	<ul style="list-style-type: none"> • Model U-3B • Weight : 75g • Size : 75(W) x 61(D) x 20(H)mm • Type of signals : <ul style="list-style-type: none"> - open collector by optocoupler (reversed) - relay contact N.C - Relay contact N.O
PLC interface U-3B	
Code	4-1041520

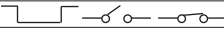
Converted signals by U-3B converter from XS-40D

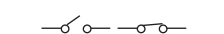
N°	Wire Color	Signal	XS-40D	Interface converter
1	ORANGE	Spare		
2	ORANGE STRIPE	Torque Up		
3	BLUE	Motor Run		
4	BLUE STRIPE	Common for 2&3 wire		
5	GREEN	Driver Lock		
6	GREEN STRIPE			
7	BROWN	No use		
8	BROWN STRIPE	Spare		

DO Series

Torque range • Auto-shut off • CE • XS-38D Controller 

0,2 to 4,41 NM



- designed for operator comfort : light weight and small sized, full ergonomic design
- designed for productivity : Robust and durable - Suitable with high production rate, Accurate shut-off clutch (+/- 3%), speed control, maintenance free (shut-off operated by magnetic sensor - no wearing)
- designed for quality : ESD free, External torque adjustment scale
- Noise level : <70 dBA, vibration level : <2,5 m/s²

DO Series

Model	Torque range (Nm)	Rotation speed (rpm)	Starting system	Drive	Weight (Kg)	Code
DO 250 ESD	0,2 - 2,45	630 or 1050	Lever	Hex 1/4"	0,72	4-1040036
DO 350 ESD	0,2 - 3,43	460 or 750	Lever	Hex 1/4"	0,72	4-1040037
DO 450 ESD	0,3 - 4,41	330 or 550	Lever	Hex 1/4"	0,72	4-1040038
DO 250 P ESD	0,2 - 2,45	630 or 1050	Push to Start	Hex 1/4"	0,72	4-1040040
DO 350 P ESD	0,2 - 3,43	460 or 750	Push to Start	Hex 1/4"	0,72	4-1040041
DO 450 P ESD	0,3 - 4,41	330 or 550	Push to Start	Hex 1/4"	0,72	4-1040042

Standard equipment (supplied with the tool)

- Power supply cable 3 m
- 2 carbon brushes
- 2 bits Philips n° 0, n° 1
- Clutch adjustment springs
- Suspension ring
- User manual

Accessories & Wear spare parts

							
Designation	Carbon brush	Brush cap	Torque ring cover	Ring for arm mounting	Extra long cable 5 m	Spiral cable 3,5 m	Pistol Grip Kit
Code	4-1041220	4-1041203	4-1041211	4-1041502	4-1044703	4-1010413	4-1010412



GA Series

Torque range • Auto-shut off • $\text{C}\epsilon$ XS-38D Controller 

0,08 to 1,18 NM



- designed for operator comfort : light weight and small sized, full ergonomic design
- designed for productivity : Accurate shut-off clutch (+/- 3%), speed control, maintenance free (shut-off operated by magnetic sensor - no wearing)
- designed for quality : ESD free, External torque adjustment scale, soft start, double hit mode.
- Noise level : <70 dBA, vibration level : <2,5 m/s²

GA Series

Model	Torque range (Nm)	Rotation speed (rpm)	Drive	Starting system	Weight (Kg)	Code
GA 150 ESD	0,08 - 0,78	700 or 1000	Hex 1/4"	Lever	0,31	4-1040011
GA 180 ESD	0,1 - 1,18	450 or 700	Hex 1/4"	Lever	0,31	4-1040012
GA 150 P ESD	0,08 - 0,78	700 or 1000	Hex 1/4"	Push to start	0,31	4-1040013
GA 180 P ESD	0,1 - 1,18	450 or 700	Hex 1/4"	Push to start	0,31	4-1040014

Standard equipment (supplied with the tool)

- Power supply cable 3 m
- 2 carbon brushes
- 2 bits Philips n° 0, n° 1
- Clutch adjustment springs
- Suspension ring
- User manual

Accessories & Wear spare parts

							
Designation	Carbon brush	Brush cap	Torque ring cover	Ring for arm mounting	Extra long cable 5 m	Spiral cable 3,5 m	Screw vacuum Pick-up
Code	4-1041219	4-1041203	4-1041212	4-1041500	4-1044703	4-1010413	4-1052500

Vacuum pick up assembly is provided without the sleeve (on request). The recommended bit length is 44 mm long. Feeting size : diameter 4 mm.

Controllers

SMPS Technology Inside!



XS-40D

- High productivity : Thanks to the unique SMPS technology (switching modulation), the connected screwdriver always delivers constant rotation speed and fastening force even for demanding fastening process (self-tapping tightening, soft joint....).
- Comfort : Light and compact.
- Durability : Built-in Over heat and Over Current protection prevent the screwdriver from damage or bad use.
- Economy : Maintenance free.
- Quality : Easy monitoring of your fastenings thanks to torque reached signal output, start and stop signal outputs, selectable softstart, Screwdriver lock signal input for PLC (prevents screwdrivers activation until PLC input signal).

Model	Power (AC) (V)	Output voltage low (V)	Output voltage high (V)	Rated output (A)	Weight (Kg)	Size (mm)	For screwdrivers 30 and 40 Volts	Code
XS-40D	220	30	40	3	0,86	90x150x55	GX, GX-G, GX...FS/GX-H Series	4-1040065
XS-40D FA	220	30	40	3	0,86	90x150x55	GXA, GXA-G, GXA-H Series	4-1040080

SMPS Technology Inside!



XS-38D

XT-30D

- High productivity : Thanks to the unique **SMPS technology** (switching modulation), the connected screwdriver always delivers constant rotation speed and fastening force even for demanding fastening process (self-tapping tightening, soft joint....)
- Comfort : Light weight and compact
- Durability : Built-in Over heat and Over Current protection prevent the screwdriver from damage or bad use
- Economy : Maintenance free
- Quality : Easy monitoring of your fastenings thanks to torque reached signal output, start and stop signal outputs, selectable softstart, Double-hit mode for soft joint, Screwdriver lock signal input for PLC (prevents screwdrivers activation until PLC input signal).

Model	Power (AC) (V)	Output voltage low (V)	Output voltage high (V)	Rated output (A)	Max. output (A)	Weight (Kg)	Size (mm)	For screwdrivers	Code
XT-30D-V2	220	20	30	1,2	2	0,33	70x130x40	GA Series	4-1099550
XS-38D V4.3*	220	30 20	38 30	2,5	5	0,7	90x150x55	DO Series GA Series	4-1040063



Controllers

- High productivity : Thanks to the unique SMPS technology (switching modulation), the connected screwdriver always delivers constant rotation speed and fastening force even for demanding fastening process (self-tapping tightening, soft joint....).
- Comfort : Light and compact.
- Durability : Built-in Over heat and Over Current protection prevent the screwdriver from damage or bad use.
- Economy : Maintenance free.
- Quality : Easy monitoring of your fastenings thanks to torque reached signal output, start and stop signal outputs, selectable softstart, Screwdriver lock signal input for PLC (prevents screwdrivers activation until PLC input signal).



Model	Power (AC) V	Output voltage	Rated output	Weight (Kg)	Size (mm)	For Screwdrivers	Code
XS-35D	220	35	4	1,2	130x188x65	GX... BT, GX... BT-G series	4-1077420

XT-35D Advanced controller features

- Password protection
- Forward and Reverse Speed selectable
- Soft start for Forward and Reverse mode (from 30 to 200 Ms)
- Programmable angle
- Multi hit function for soft joint (from 1 to 10 shut off clutch)
- Multi sequence programm (as GXT model)
- Various Display Settings
- I/O interface
- RJ input for Scout II poka yoke Controller, Posi Control



Model	Power (AC) V	Output voltage	Rated output	Weight (Kg)	Size (mm)	For Screwdrivers	Code
XT-35D	230	35	4	2,4	95x221x143	GY..., GY-G series PGY..., PGY-G series	4-1077421

SCOUT Poka Yoke

SCOUT Poka yoke controller (Suitable with XS-38D, XS-38D FA, XS-40D, XS-35D, XT-35D)

**Prevents screw fastening errors!
Supervised process!**



Set up to 8 tightening programs

Tightening monitoring :

- Detects cross threading, omissions, double tightening, unfinished rundown.
- Screws counting, OK-NG fastening, OK-NG cycle.
- Buzzer Alert, displays error conditions.

Sequence management :

- Parts detection, parts OK-NG sorting through PLC.
- Storage of several tightening settings with the parameter mode.

Model	Key features	Inputs features	Outputs features	Code
SCOUT II	<ul style="list-style-type: none"> > Password protection > Display of total fastened screw number > Display of remaining screw number > Built-in fastening time measurement function > Alarms: leds + several buzzers > Easy programming by scroll menu and self learning mode > Wall mountable 	<ul style="list-style-type: none"> > Cycle start > Driver lock/unlock 	<ul style="list-style-type: none"> > OK > NG > Buzzer alarm > Cycle end 	4-1074000

Delivered with :

- Connection cable on controller
- I/O connection cable

**Easy programming thanks
to the Scout II manager
software !**





8, avenue Gutenberg - CS 50510
78317 Maurepas Cedex - France
Tél. : +33 1 30 66 41 20 • Fax : + 33 1 30 66 41 79
export@doga.fr

Nous travaillons constamment à l'amélioration de nos produits. De ce fait, les dimensions et indications portées dans cette brochure peuvent parfois ne pas correspondre aux dernières exécutions. De convention expresse, nos ventes sont faites sous bénéfice de réserve de propriété (les dispositions de la loi du 12/5/80 trouvent donc toute leur application).